

Dış Mekan Sistemi
Outdoor System



SH110

Motorlu Giyotin Sistemi
Motorized Guillotine System

SH110 Motorlu Giyotin Sistemi

SH110 Motorized Guillotine System

TEKNİK ÖZELLİKLER / TECHNICAL PROPERTIES

Üst Kutu Profil Genişliği / Top Tube Profile Width	134 mm
Üst Kutu Profil Yüksekliği / Top Tube Profile Height	170 mm
Kanat Profil Genişliği / Sash Profile Width	25 mm
Kanat Profil Yüksekliği / Sash Profile Height	38 mm
Profil Et Kalınlığı / Profile Wall Thickness	2,5 - 1,3 mm
Cam Kalınlığı / Glazing Thickness	8 - 20 mm
Maks. Kanat Genişliği / Max. Sash Width	3500 mm
Maks. Kanat Yüksekliği / Max. Sash Height	1000 mm
Maks. Kanat Ağırlığı / Max. Sash Weight	70 kg
Maks. Kanat Sayısı / Max. Sash Number	4

UYGULAMA SEÇENEKLERİ / APPLICATION OPTIONS

Üst Küpeşteli, Alt Eşikli Sistem

Top Handrail, Bottom Threshold System



Üst Küpeştersiz, Alt Eşikli Sistem

Without Top Handrail, Bottom Threshold System



Üst Küpeşteli, Alt Eşiksiz Sistem

Top Handrail, Without Bottom Threshold System



Üst Küpeştersiz, Alt Eşiksiz Sistem

Without Top Handrail, Without Bottom Threshold System



Kayıslı Askı Tipi / Belt Strap



Zincirli Askı Tipi / Chained Strap

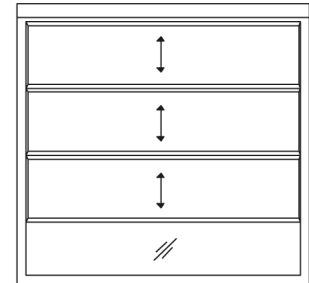
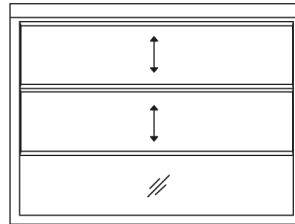
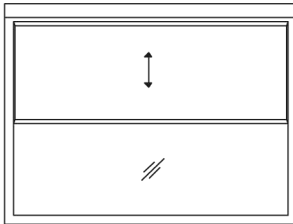

PROF L KES T PROFILE SECTION	PROF L KODU PROFILE CODE	PROF L ADI PROFILE NAME	Jx cm ⁴	Jy cm ⁴	A IRLIK (kg/m) WEIGHT
	10550	ÜST KUTU PROF L TOP TUBE PROFILE	-	-	2,978 kg/m
	10551	KUTU KAPAK PROF L TUBE COVER PROFILE	-	-	1,186 kg/m
	10559	YATAY PROF L TRANSOM PROFILE	-	-	1,045 kg/m
	10552	D KME PROF L POLE PROFILE	-	-	1,927 kg/m
	10553	D KME PROF L POLE PROFILE	-	-	0,492 kg/m
	10554	KANAT PROF L SASH PROFILE	-	-	0,637 kg/m
	10555	KANAT PROF L SASH PROFILE	-	-	0,761 kg/m
	10556	KENET PROF L INTERLOCK PROFILE	-	-	0,411 kg/m
	10557	B T PROF L END PROFILE	-	-	0,245 kg/m
	8063	KANAL KAPAK PROF L COVER PROFILE	-	-	0,137 kg/m
	5992	KAPAK PROF L COVER PROFILE	-	-	0,080 kg/m
	8241	T J PROF L STEM BAR PROFILE	-	-	0,099 kg/m

AKSESUAR ACCESSORY	STOK KODU REFERENCE CODE	AKSESUAR ADI DESCRIPTION	AKSESUAR KODU PRODUCT CODE	PAKET PACK
	14 100100	YAN KAPAK COVER	SH110-YK.100	1 pk / 1 ad
	01 130306	KÖ E BA LANTI CORNER CONNECTION	SH110-MC.306	1 pk / 250 ad
	14 100107	YATAY PROF L (TRABZAN KAPA I) HORIZONTAL TRANSOM COVER	SH110-YP.107	1 pk / 1 tk
	14 100120	70 L K BORU (1,2 mm) Ø70 TUBE (1,2 mm)	SH110-BR.120	1 boy / 6 mt
	14 100105	BORU BA I TUBE PLUG	SH110-BB.105	1 pk / 1 ad
	14 100106	RULMAN ROLLER	SH110-RL.106	1 pk / 1 ad
	14 100102	KASNAK GEAR	SH110-KS.102	1 pk / 1 ad
	14 100103	RULMAN PLAKASI ROLLER COVER	SH110-RP.103	1 pk / 1 ad
	14 100115	YÜK KAYI I LOAD SECURING STROP	SH110-YK.115	1 pk / 25 mt
	14 100108	KAYI TEKERLEK ADAPTÖRÜ STROP WHEEL ADAPTER	SH110-KT.108	1 pk / 50 ad
	14 100111	KANAT H ZA TEKER SASH ALIGNMENT WHEEL	SH110-KH.111	1 pk / 8 ad
	08 050155	POL ÜRETAN YAPI TIRICI POLIURETAN ADHESIVE	SH110-PY.155	1 pk / 24 ad
	14 100104	ASKI TAKIMI HANGER SET	SH110-AT.104	1 pk / 2 ad
	11 010201	Ø3.9x16 YSB MATKAP UÇLU V DA Ø3.9x16 SELF DRILLING CURVED TOP SCREW	SH110-SC.201	1 pk / 1000 ad
	11 010225	Ø4.8x60 YSB MATKAP UÇLU V DA Ø4.8x60 SELF DRILLING CURVED TOP SCREW	SH110-SC.225	1 pk / 500 ad
	03 050707	FIRÇA F T L (6.8 - 5.5 mm) WEATHER STRIP (6.8 - 5.5 mm)	SH110-FÇ.707	400 metre
	03 050712	FIRÇA F T L (6.8 - 10 mm) WEATHER STRIP (6.8 - 10 mm)	SH110-FÇ.712	200 metre
	09 080161	MOSEL SEL-70 120Nm RADYO ALICILI G YOT N MOTORU MOSEL SEL-70 120 Nm GUILLOTINE MOTOR WITH RECEIVER	SH110-MSR.161	1 pk / 1 ad
	09 080407	DC 104 MOSEL TEKL VER C KUMANDA DC 104 MOSEL REMOTE CONTROL	SH110-DC.407	1 pk / 1 ad
	14 100140	SOMFY ALTUS 60 RTS 120/12 VVF 3 m KEND N DEN ALICILI G YOT N MOTORU SOMFY ALTUS 60 RTS 120/12 VVF 3 m GUILLOTINE MOTOR WITH RECEIVER	SH110-SMA.140	1 pk / 1 ad
	14 100145	SOMFY TEL S 1 RTS PURE TEK KANALLI KUMANDA SOMFY TELIS 1 RTS PURE REMOTE CONTROL	SH110-SMT.145	1 pk / 1 ad
	14 100130	ASA MARCONI 60 ST 120/12 KEND N DEN ALICILI G YOT N MOTORU ASA MARCONI 60 ST 120/12 GUILLOTINE MOTOR WITH RECEIVER	SH110-AMR.130	1 pk / 1 ad
	14 100135	ASA GO-1 ELEGANCE TEK KANALLI KUMANDA ASA GO-1 ELEGANCE REMOTE CONTROL	SH110-AGK.135	1 pk / 1 ad

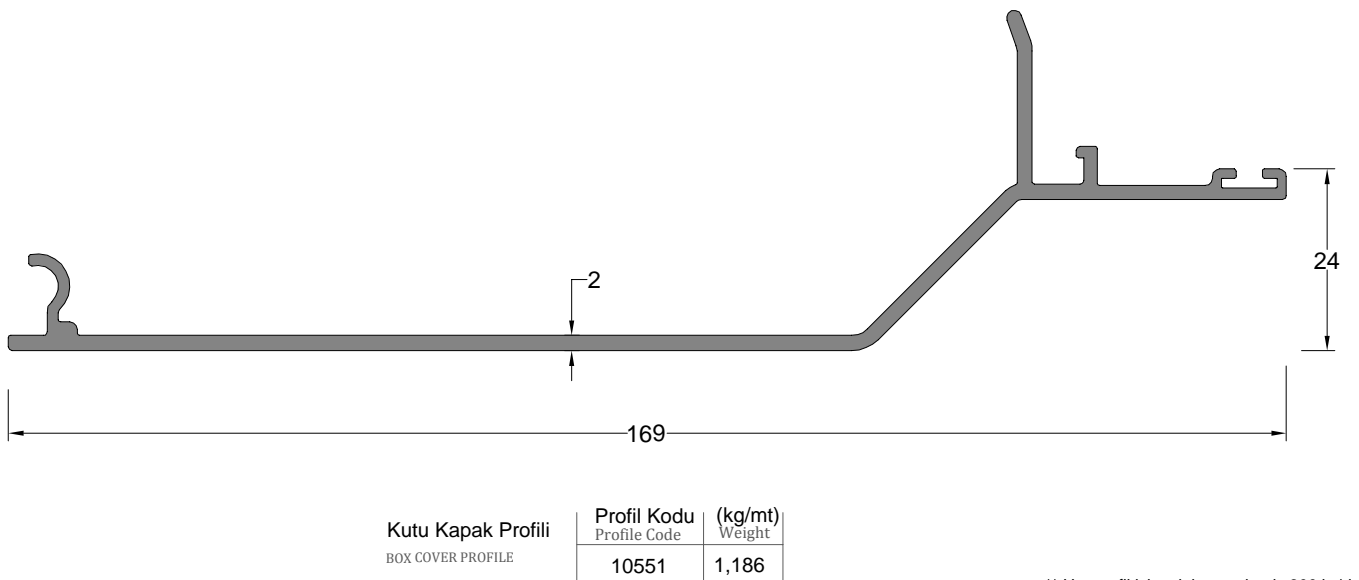
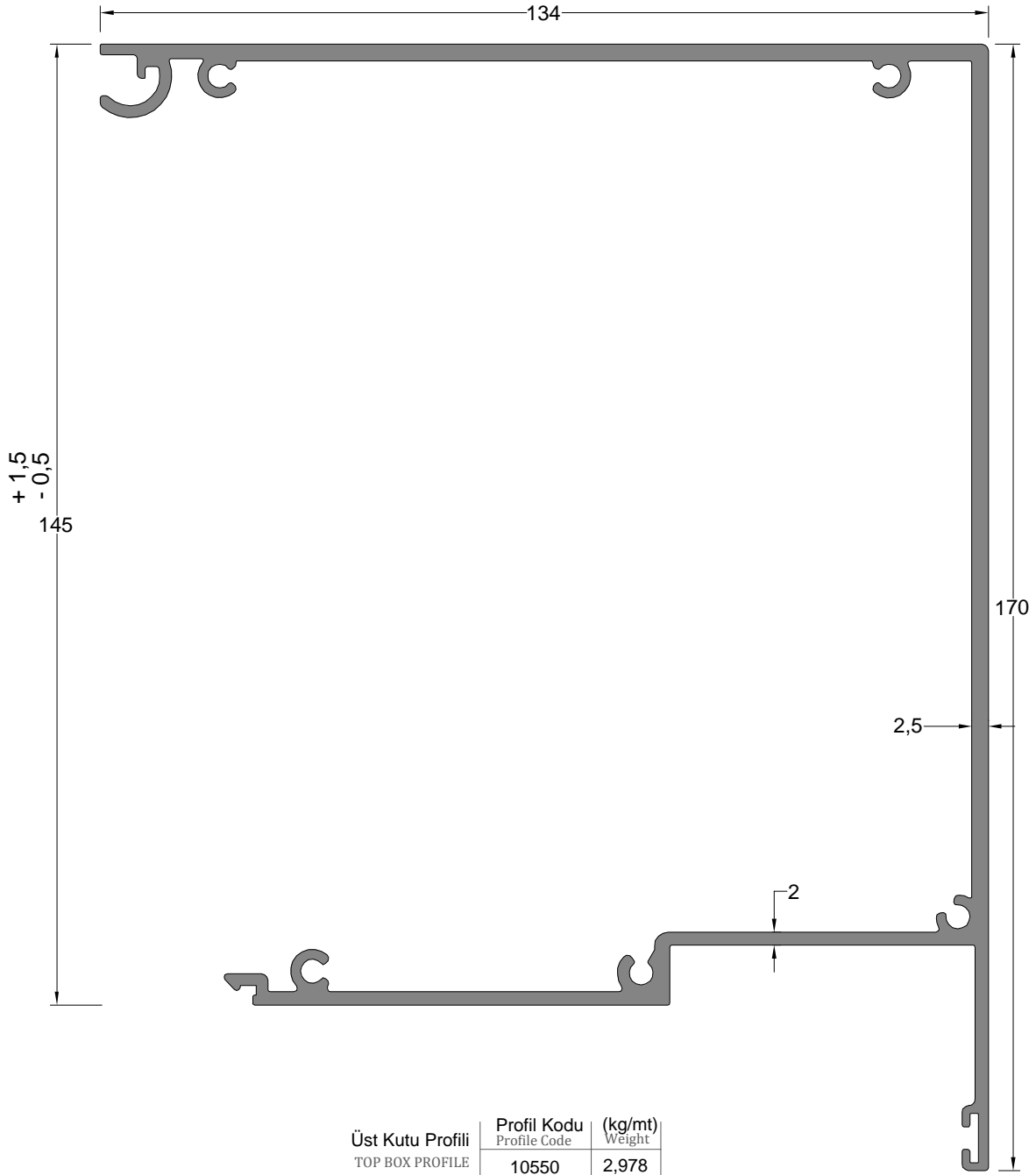

** Her profil için minimum sipari 300 kg'dır.
** Minimum order quantity is 300 kg per profile.

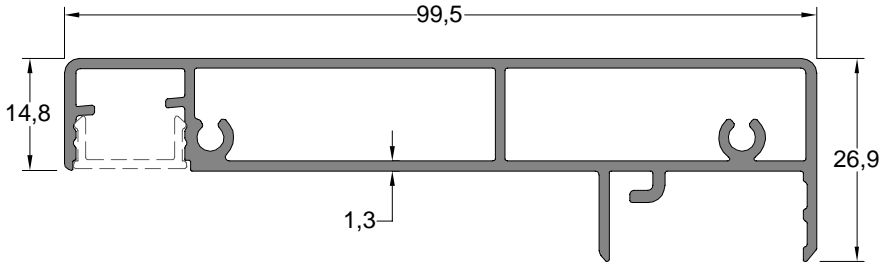

Yatay Profili	Profil Kodu	(kg/mt)
TRANSOM PROFILE	Profile Code	Weight
	10559	1,045

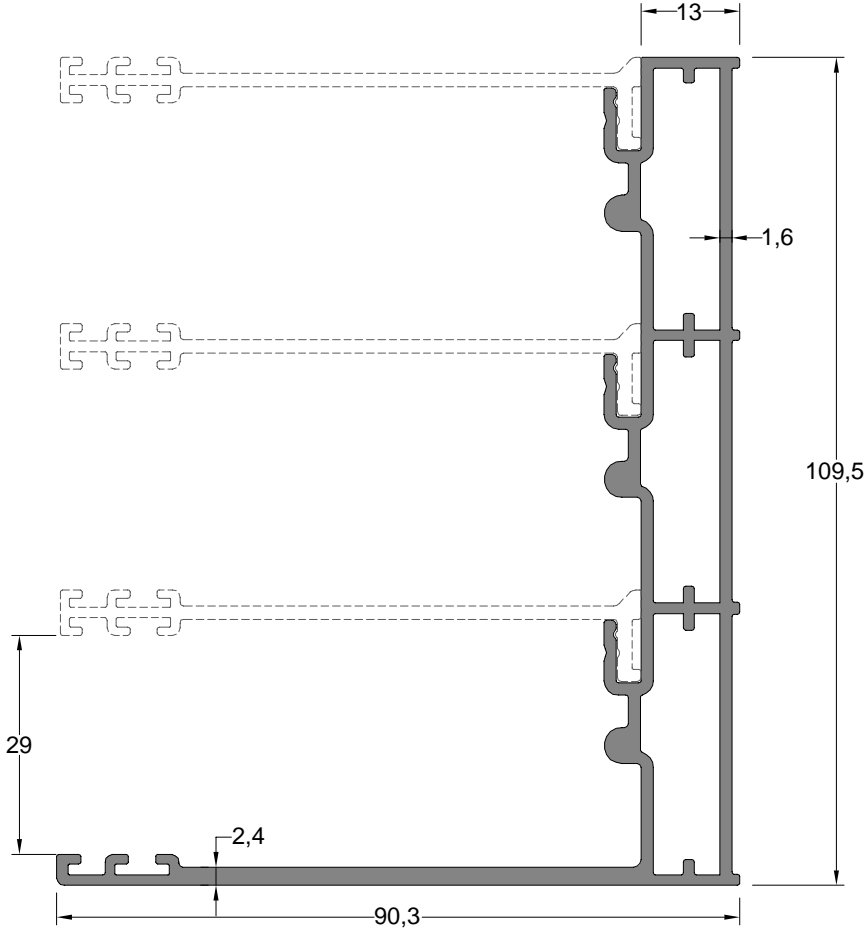

Dikme Profili	Profil Kodu	(kg/mt)
POLE PROFILE	Profile Code	Weight
	10552	1,927

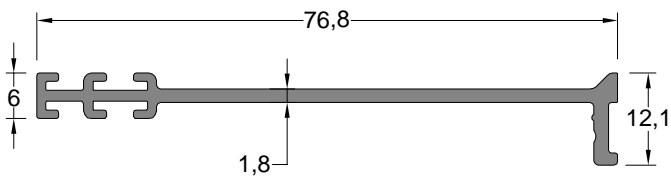

Dikme Profili	Profil Kodu	(kg/mt)
POLE PROFILE	Profile Code	Weight
	10553	0,492

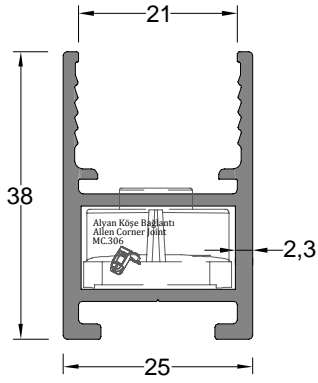

Kanat Profili	Profil Kodu	(kg/mt)
SASH PROFILE	Profile Code	Weight
	10554	0,637

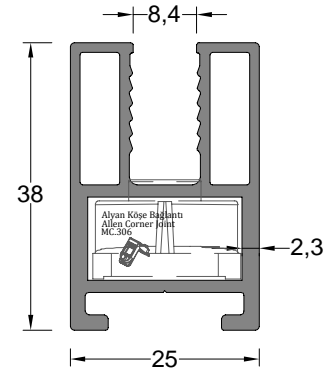

Kanat Profili	Profil Kodu	(kg/mt)
SASH PROFILE	Profile Code	Weight
	10555	0,761

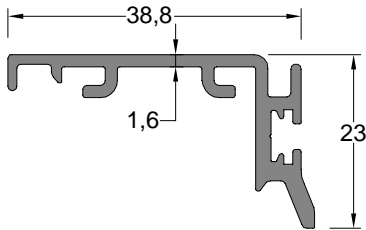

Kenet Profili	Profil Kodu	(kg/mt)
INTERLOCK PROFILE	Profile Code	Weight
	10556	0,411

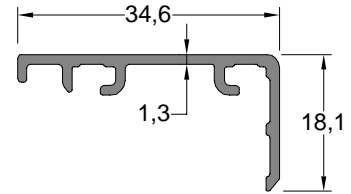

Biti Profili	Profil Kodu	(kg/mt)
END PROFILE	Profile Code	Weight
	10557	0,245

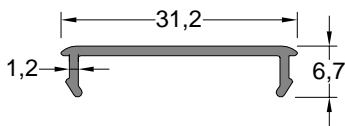

Kapak Profili	Profil Kodu	(kg/mt)
COVER PROFILE	Profile Code	Weight
	8063	0,137

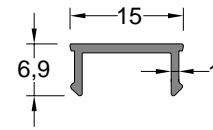

Kapak Profili	Profil Kodu	(kg/mt)
COVER PROFILE	Profile Code	Weight
	5992	0,080

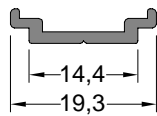

Tij Profili	Profil Kodu	(kg/mt)
STEM BAR PROFILE	Profile Code	Weight
	8241	0,099

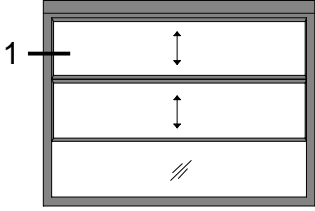

Ç
(INSIDE)

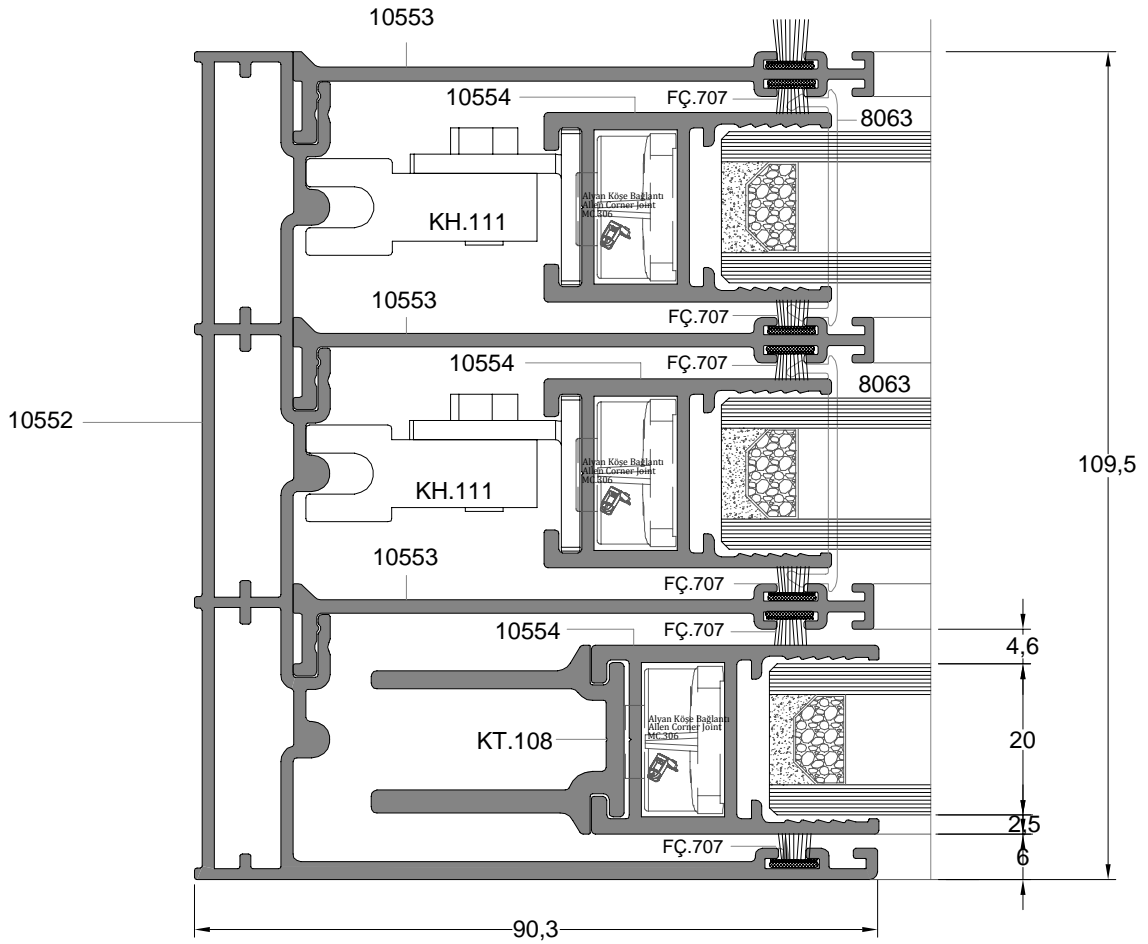

DI
(OUTSIDE)

D-1

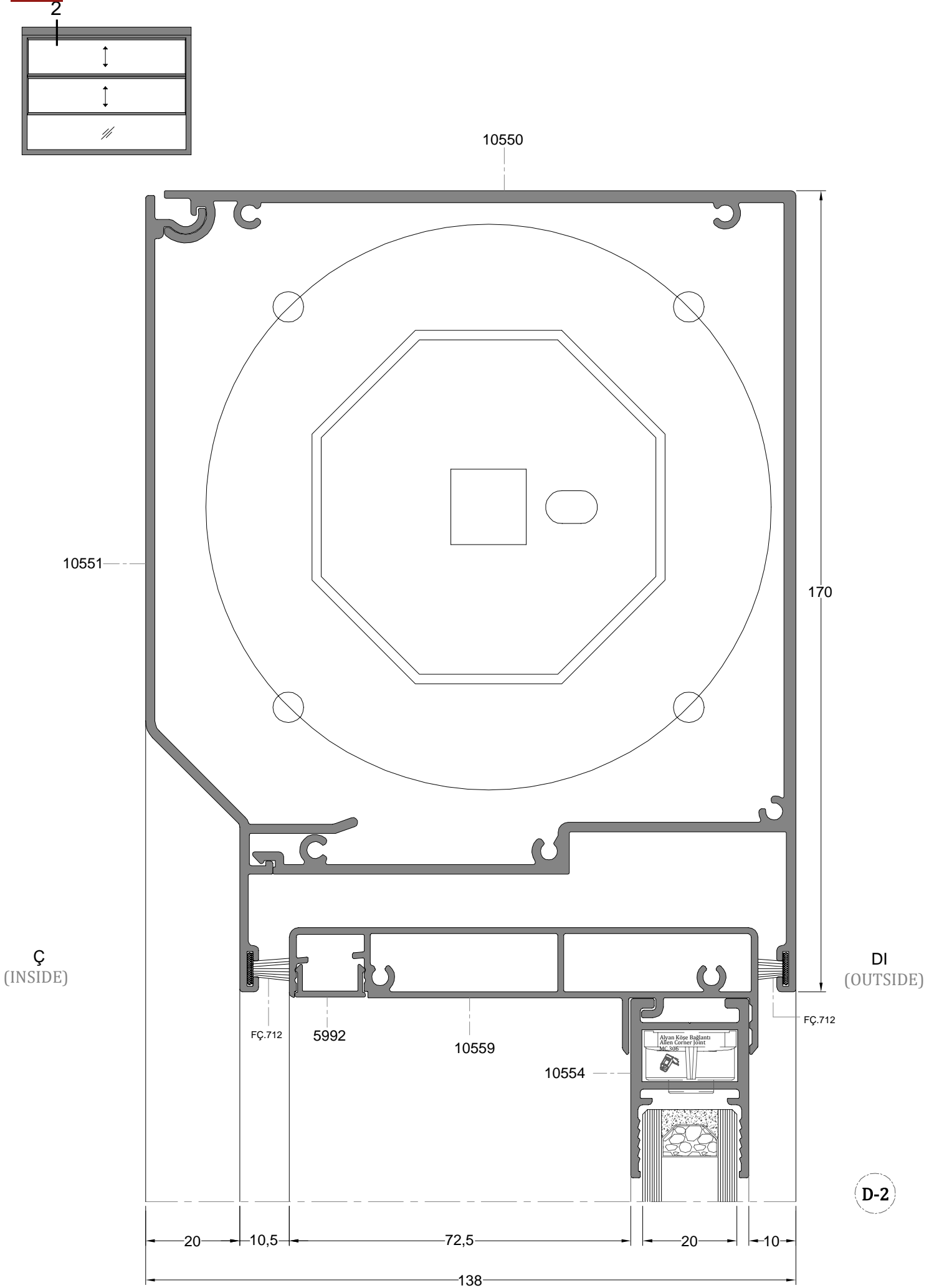

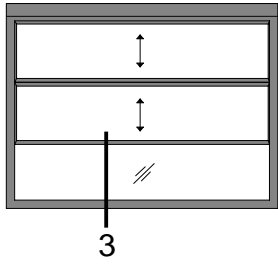

Ç
(INSIDE)

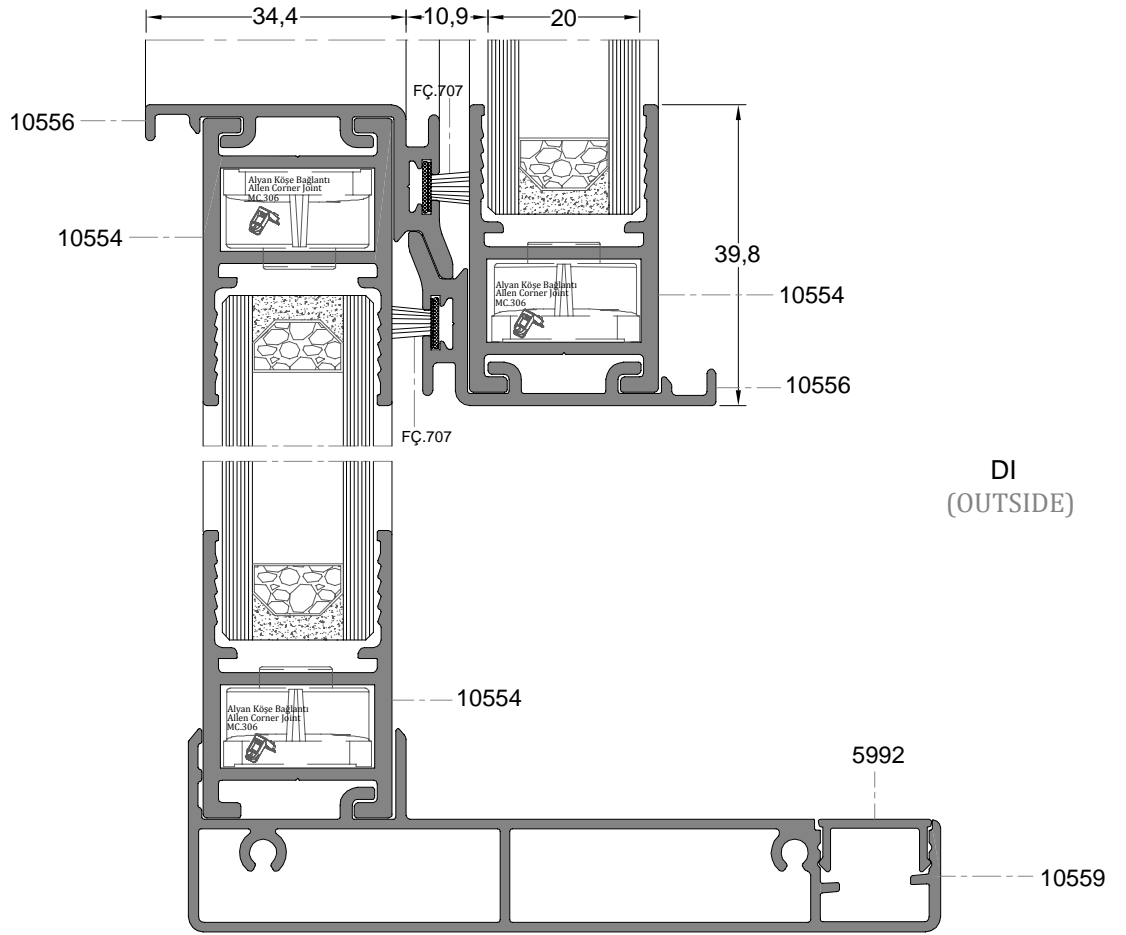

DI
(OUTSIDE)

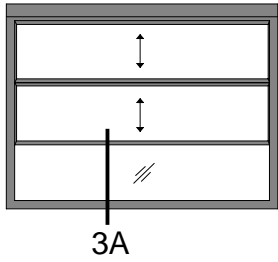

Ç
(INSIDE)

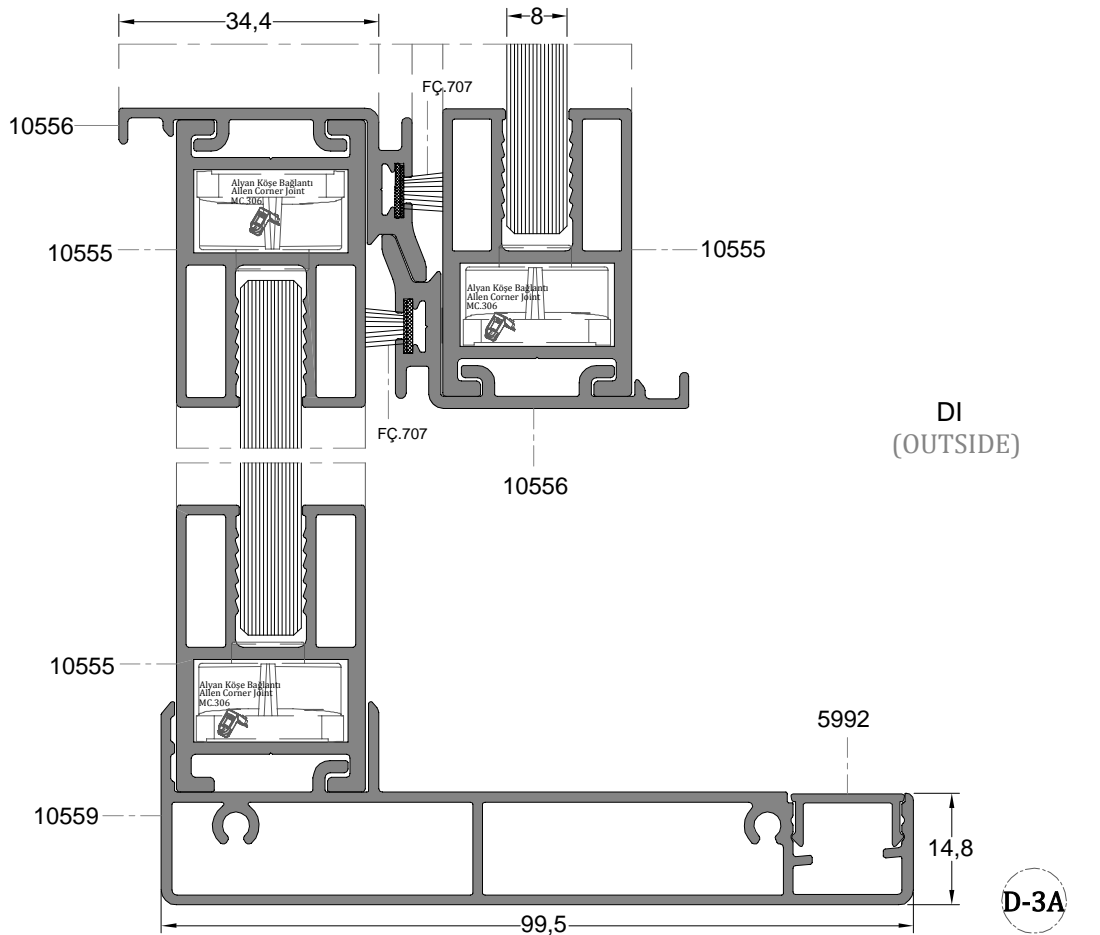

DI
(OUTSIDE)

D-3

D-3A

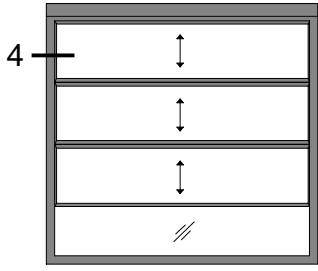

Ç
(INSIDE)

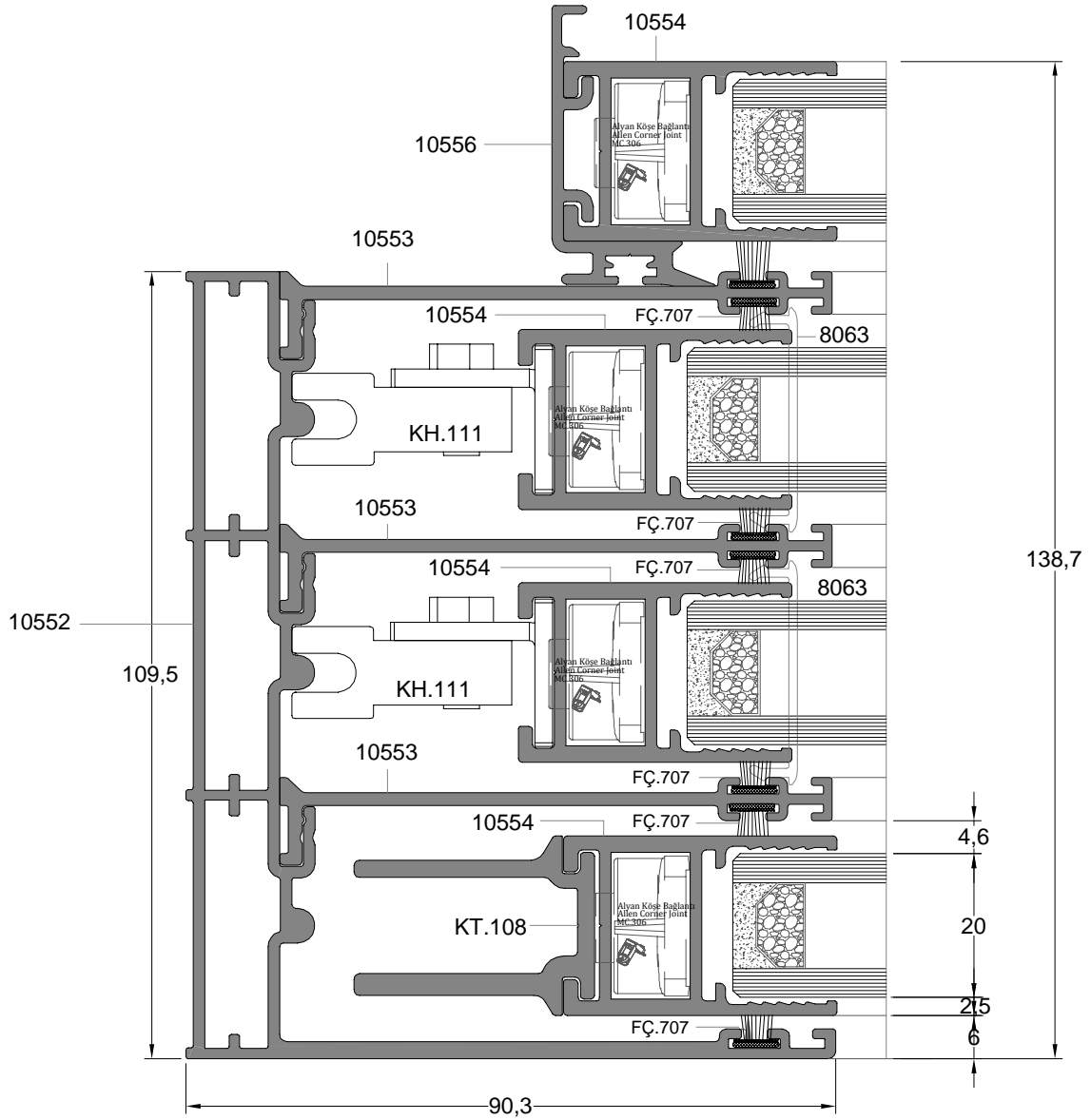

DI
(OUTSIDE)

D-4

KAPALI S STEM
CLOSED SYSTEM

ÖLÇEK:1/2
SCALE:1/2

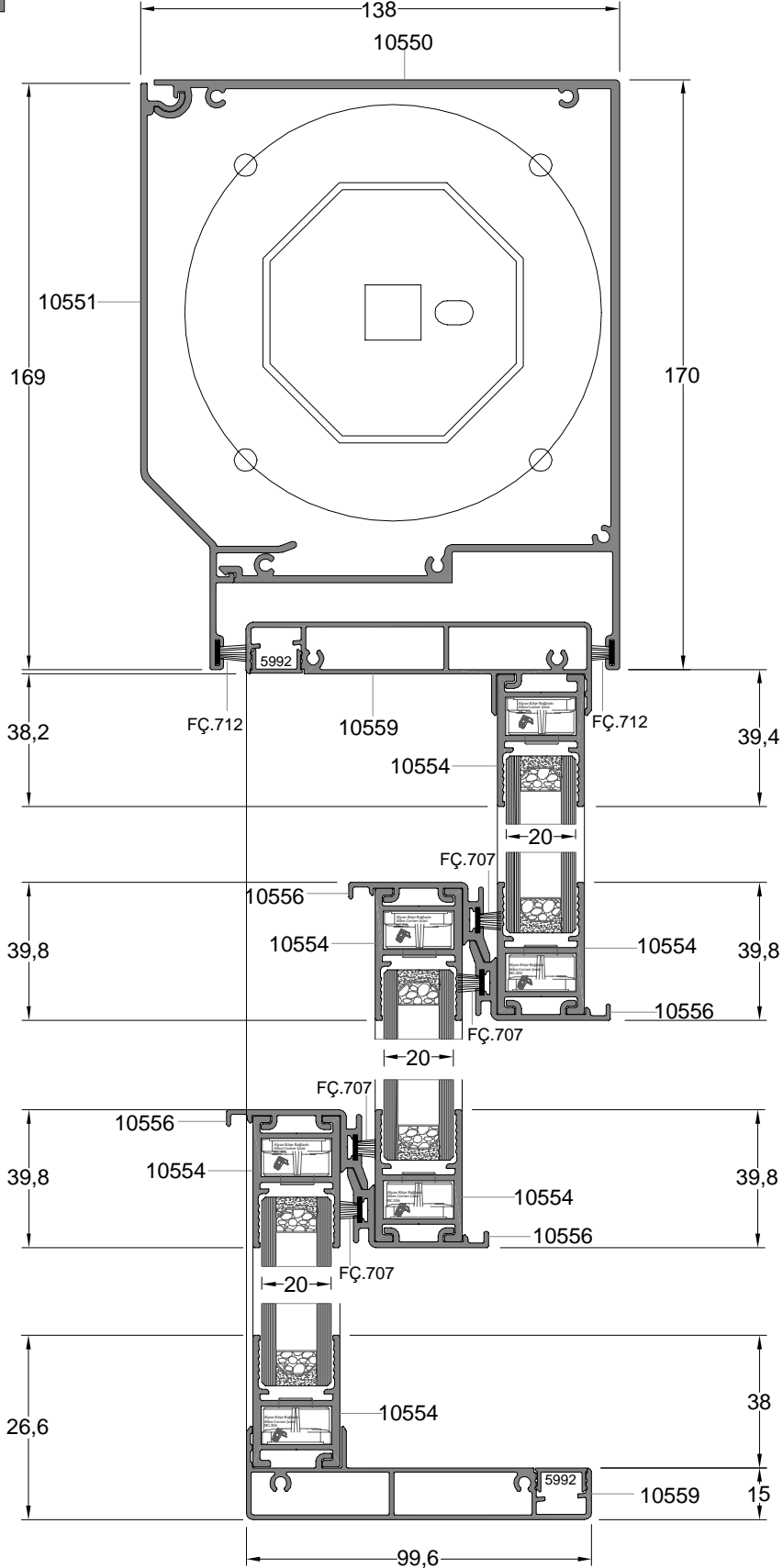
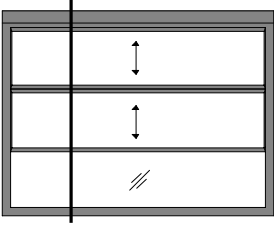

AÇIK S STEM
OPEN SYSTEM

ÖLÇEK:1/2
SCALE:1/2

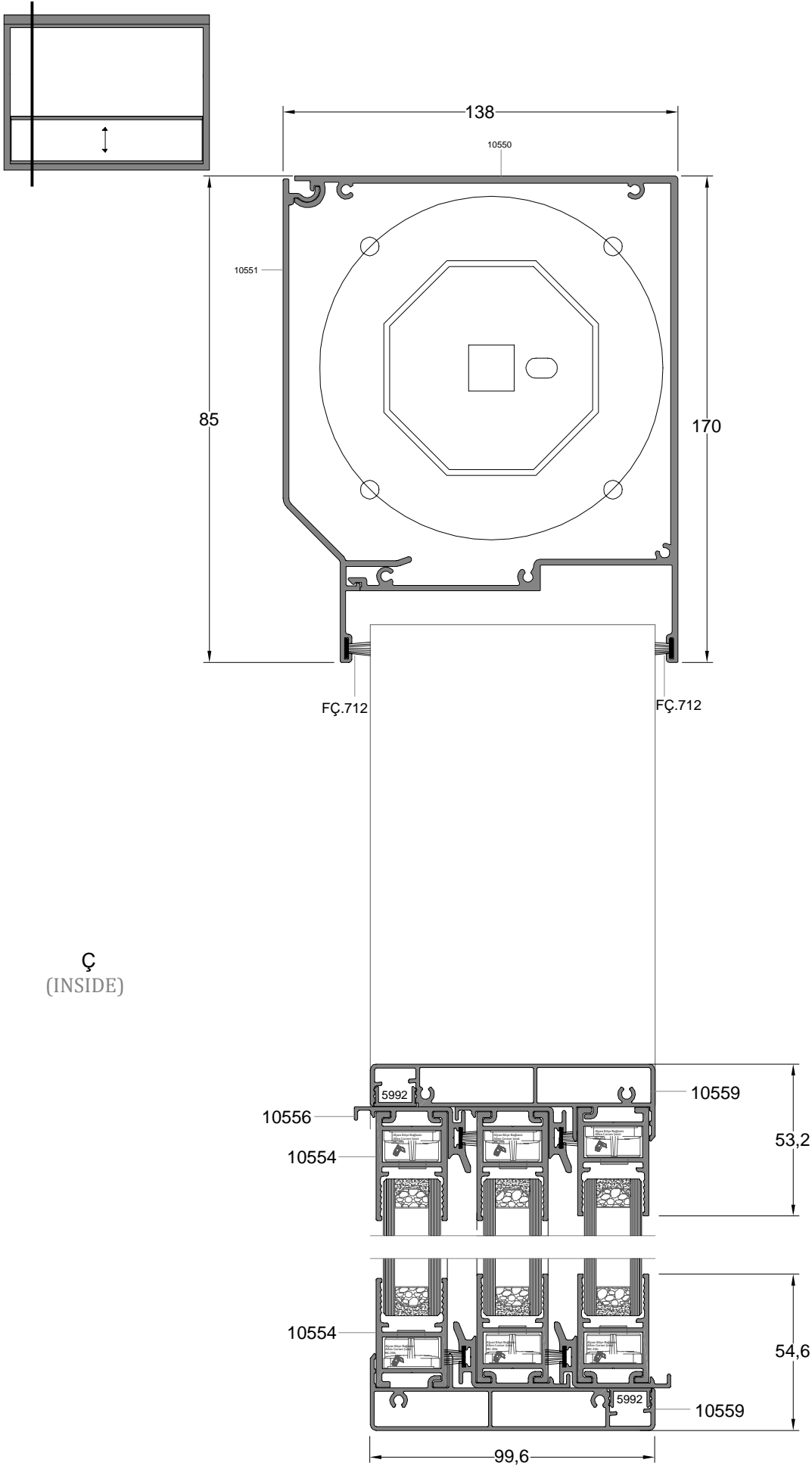

ÜST TRANSOMSUZ ALT EŞİKLİ DETAY (EŞİT ÖLÇÜ)

Cam Özelli i Glass Feature	Cam Ölçüsü Glass Dimensions	Adet Quantity
4 + 12 + 4 mm 5 + 10 + 5 mm 6 + 8 + 6 mm	Kanat Ölçüsü - 50 mm 2845 mm x 917 mm	3 adet

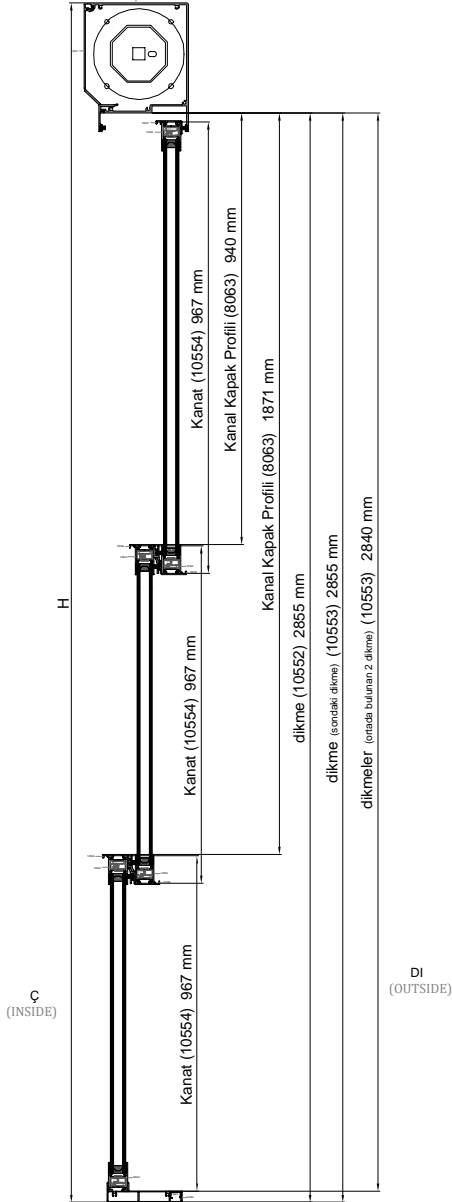
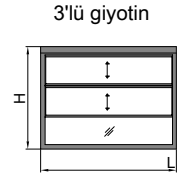

Profil Resmi Profile Picture	Açıklama Description	Kesim Ölçüsü Cutting Dimension	Adet Quantity	Kesim ekli Cutting Shape
	10550 Kutu Profili Tube Profile	L - 12	1 Adet	
	10551 Kutu Kapak Profili Tube Cover Profile	L - 12	1 Adet	
	10554 Kanat Profili Sash Profile	(H - 99) / 3	6 Adet	
		L - 105	6 Adet	
	10557 Biti Profili End Profile	L - 190	1 Adet	
	10556 Kenet Profili Interlock Profile	L - 186	4 Adet	
	10559 Yatay Profili Transom Profile	L - 36	1 Adet	
	5992 Kapak Profili Cover Profile	L - 190	1 Adet	
	10552 Dikme Profili Mullion Profile	H - 145	2 Adet	
	10553 Dikme Profili Mullion Profile	H - 145	2 Adet	
	8063 Kanal Kapak Profili Cover Profile	H - 160	4 Adet	
		H - 2060	2 Adet	
	8063 Kanal Kapak Profili Cover Profile	H - 1129	2 Adet	
		H - 2060	2 Adet	

ALTERNATİF KANAT

	10555 Kanat Profili Sash Profile	(H - 99) / 3	6 Adet	
		L - 105	6 Adet	

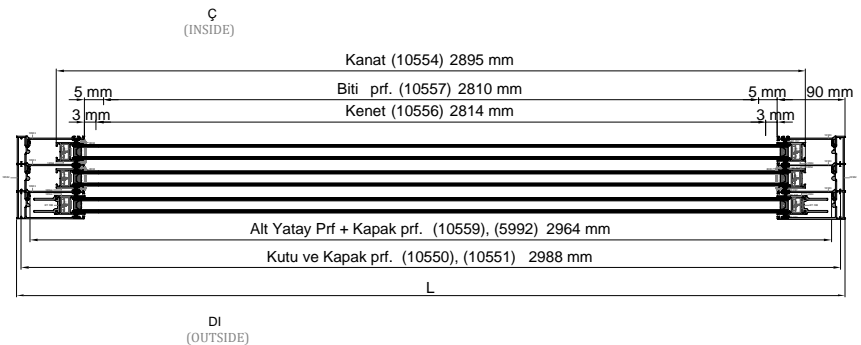

ÜST TRANSOMLU ALT EŞİKLİ DETAY (EŞİT ÖLÇÜ)

Cam Özelli i Glass Feature	Cam Ölçüsü Glass Dimensions	Adet Quantity
4 + 12 + 4 mm 5 + 10 + 5 mm 6 + 8 + 6 mm	Kanat Ölçüsü - 50 mm 2845 mm x 912 mm	3 adet

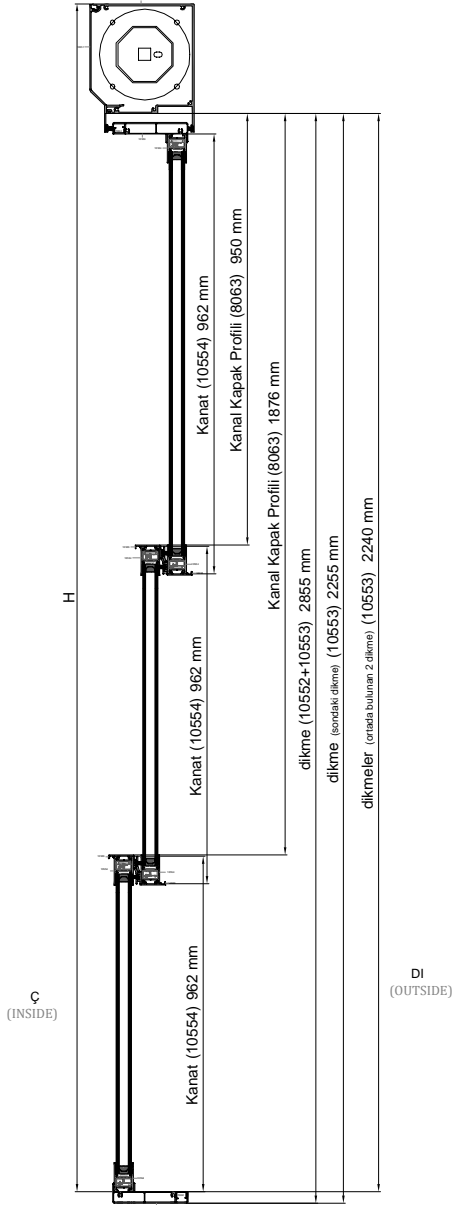
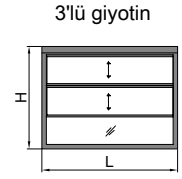

Profil Resmi Profile Picture	Açıklama Description	Kesim Ölçüsü Cutting Dimension	Adet Quantity	Kesim ekli Cutting Shape
	10550 Kutu Profili Tube Profile	L - 12	1 Adet	
	10551 Kutu Kapak Profili Tube Cover Profile	L - 12	1 Adet	
	10554 Kanat Profili Sash Profile	(H - 114) / 3	6 Adet	
		L - 105	6 Adet	
	10556 Kenet Profili Interlock Profile	L - 186	4 Adet	
	10559 Yatay Profili Transom Profile	L - 190	1 Adet	
	10559 Yatay Profili Transom Profile	L - 36	1 Adet	
	5992 Kapak Profili Cover Profile	L - 190	1 Adet	
	5992 Kapak Profili Cover Profile	L - 36	1 Adet	
	10552 Dikme Profili Mullion Profile	H - 145	2 Adet	
	10553 Dikme Profili Mullion Profile	H - 145	2 Adet	
	10553 Dikme Profili Mullion Profile	H - 160	4 Adet	
		H - 2050	2 Adet	
	8063 Kanal Kapak Profili Cover Profile	H - 1124	2 Adet	
		H - 1124	2 Adet	

ALTERNATİF KANAT

	10555 Kanat Profili Sash Profile	(H - 114) / 3	6 Adet	
		L - 105	6 Adet	

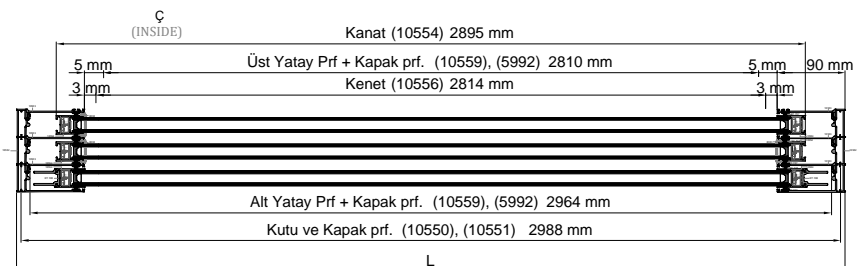

ÜST TRANSIMSUZ ALT EŞİKLİ DETAY (EŞİT OLMAYAN ÖLÇÜ)

Cam Özelli i Glass Feature	Cam Ölçüsü Glass Dimensions	Adet Quantity
4 + 12 + 4 mm	Kanat Ölçüsü - 50 mm 2845 mm x 901 mm	2 adet
5 + 10 + 5 mm	Kanat Ölçüsü- 50 mm 2845 mm x 950 mm	1 adet

3'lü giyotin

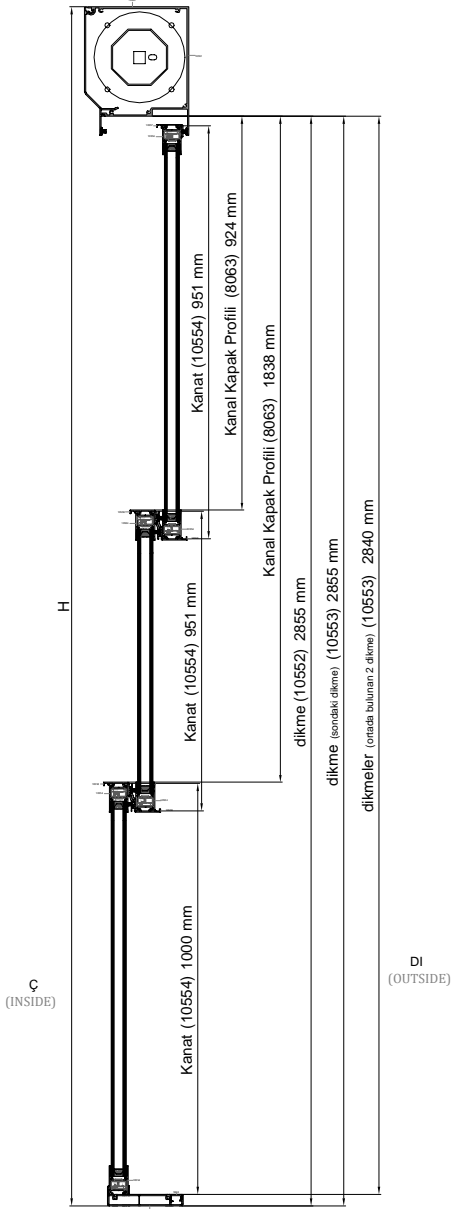
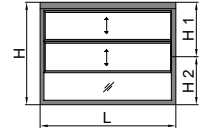

Profil Resmi Profile Picture	Açıklama Description	Kesim Ölçüsü Cutting Dimension	Adet Quantity	Kesim ekli Cutting Shape
	10550 Kutu Profili Tube Profile	L - 12	1 Adet	
	10551 Kutu Kapak Profili Tube Cover Profile	L - 12	1 Adet	
	10554 Kanat Profili Sash Profile	(H/3 - 49)	4 Adet	
		(H/3)	2 Adet	
		L - 105	6 Adet	
	10557 Biti Profili End Profile	L - 190	1 Adet	
	10556 Kenet Profili Interlock Profile	L - 186	4 Adet	
	10559 Yatay Profili Transom Profile	L - 36	1 Adet	
	5992 Kapak Profili Cover Profile	L - 36	1 Adet	
	10552 Dikme Profili Mullion Profile	H - 145	2 Adet	
	10553 Dikme Profili Mullion Profile	H - 145	2 Adet	
	10553 Dikme Profili Mullion Profile	H - 160	4 Adet	
		H - 2076	2 Adet	
	8063 Kanal Kapak Profili Cover Profile	H - 1162	2 Adet	
		H - 1162	2 Adet	

ALTERNATİF KANAT

	10555 Kanat Profili Sash Profile	(H/3 - 49)	4 Adet	
		(H/3)	2 Adet	
		L - 105	6 Adet	

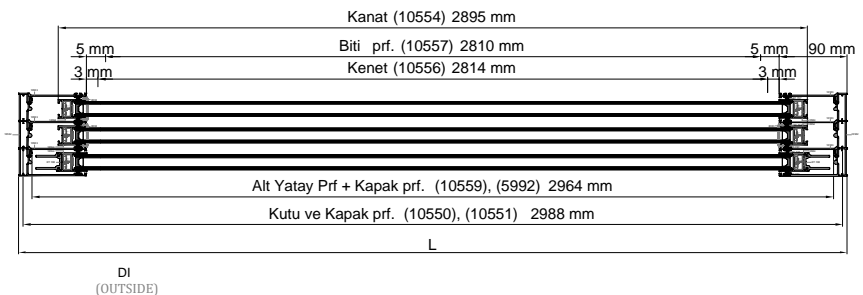
 C
 (INSIDE)

 DI
 (OUTSIDE)

ÜST TRANSOMLU ALT EŞİKLİ DETAY (EŞİT OLMAYAN ÖLÇÜ)

Cam Özelli i Glass Feature	Cam Ölçüsü Glass Dimensions	Adet Quantity
4 + 12 + 4 mm	Kanat Ölçüsü - 50 mm	2 adet
5 + 10 + 5 mm	2845 mm x 893 mm	
6 + 8 + 6 mm	Kanat Ölçüsü- 50 mm	1 adet
	2845 mm x 950 mm	

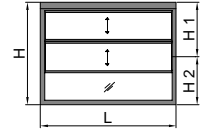
3'lü giyotin



Profil Resmi Profile Picture	Açıklama Description	Kesim Ölçüsü Cutting Dimension	Adet Quantity	Kesim ekli Cutting Shape
	10550 Kutu Profili Tube Profile	L - 12	1 Adet	
	10551 Kutu Kapak Profili Tube Cover Profile	L - 12	1 Adet	
	10554 Kanat Profili Sash Profile	(H/3 - 57)	4 Adet	
		(H/3)	2 Adet	
		L - 105	6 Adet	
	10556 Kenet Profili Interlock Profile	L - 186	4 Adet	
	10559 Yatay Profili Transom Profile	L - 190	1 Adet	
	10559 Yatay Profili Transom Profile	L - 36	1 Adet	
	5992 Kapak Profili Cover Profile	L - 190	1 Adet	
	5992 Kapak Profili Cover Profile	L - 36	1 Adet	
	10552 Dikme Profili Mullion Profile	H - 145	2 Adet	
	10553 Dikme Profili Mullion Profile	H - 145	2 Adet	
	10553 Dikme Profili Mullion Profile	H - 160	4 Adet	
	8063 Kanal Kapak Profili Cover Profile	H - 2069	2 Adet	
		H - 1162	2 Adet	

ALTERNATİF KANAT

	10555 Kanat Profili Sash Profile	(H/3 - 57)	4 Adet	
		(H/3)	2 Adet	
		L - 105	6 Adet	

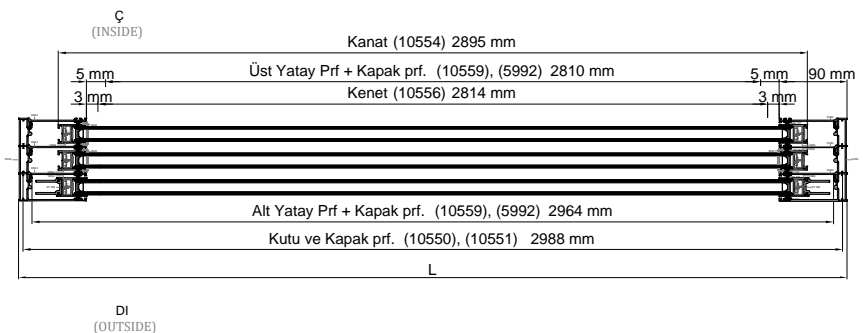
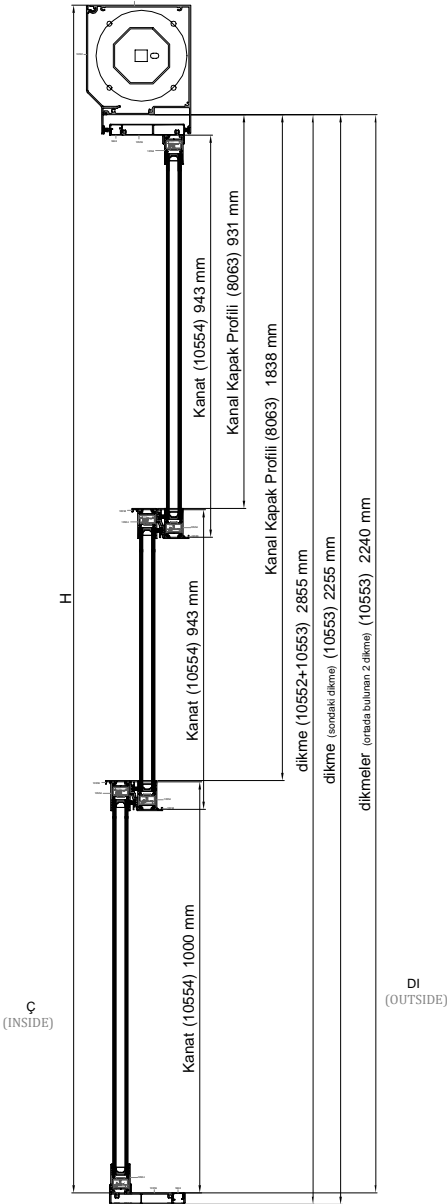

ÜST TRANSOMSUZ ALT EŞİKLİ DETAY (EŞİT ÖLÇÜ)

Cam Özelli i Glass Feature	Cam Ölçüsü Glass Dimensions	Adet Quantity
4 + 12 + 4 mm 5 + 10 + 5 mm 6 + 8 + 6 mm	Kanat Ölçüsü - 50 mm 2845 mm x 688 mm	4 adet

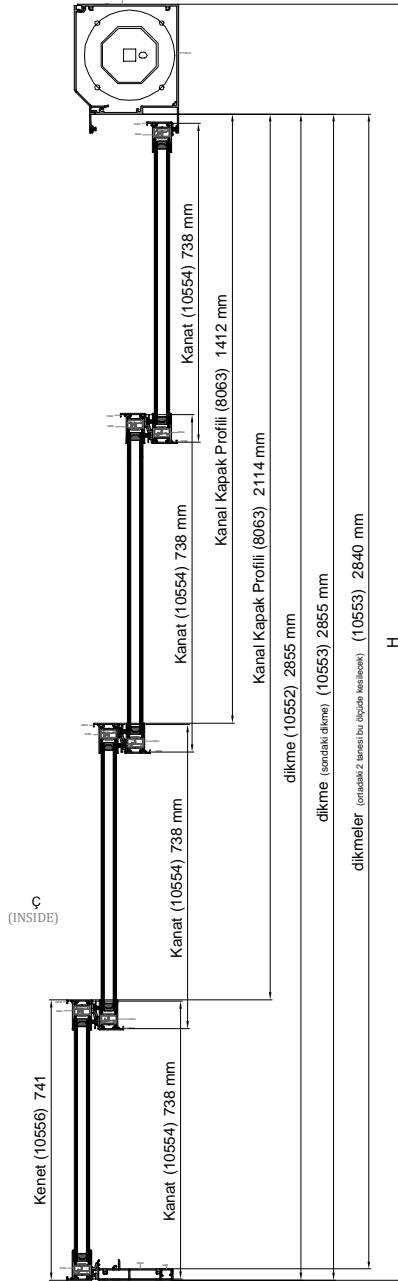
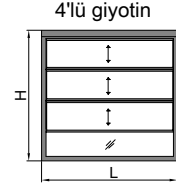

Profil Resmi Profile Picture	Açıklama Description	Kesim Ölçüsü Cutting Dimension	Adet Quantity	Kesim ekli Cutting Shape
	10550 Kutu Profili Tube Profile	L - 12	1 Adet	
	10551 Kutu Kapak Profili Tube Cover Profile	L - 12	1 Adet	
	10554 Kanat Profili Sash Profile	(H - 48) / 4	8 Adet	
		L - 105	8 Adet	
	10557 Biti Profili End Profile	L - 190	1 Adet	
	10556 Kenet Profili Interlock Profile	(H / 4) - 9	2 Adet	
		L - 186	7 Adet	
	10559 Yatay Profili Transom Profile	L - 36	1 Adet	
	5992 Kapak Profili Cover Profile	L - 36	1 Adet	
	10552 Dikme Profili Mullion Profile	H - 145	2 Adet	
	10553 Dikme Profili Mullion Profile	H - 145	2 Adet	
	10553 Dikme Profili Mullion Profile	H - 160	4 Adet	
		H - 1588	2 Adet	
	8063 Kanal Kapak Profili Cover Profile	H - 886	2 Adet	
		H - 886	2 Adet	

ALTERNATİF KANAT

	10555 Kanat Profili Sash Profile	(H - 48) / 4	8 Adet	
		L - 105	8 Adet	

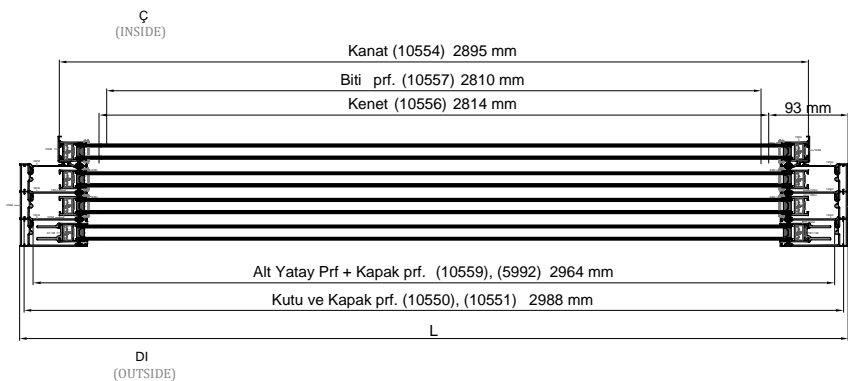

ÜST TRANSOMLU ALT EŞİKLİ DETAY (EŞİT ÖLÇÜ)

Cam Özelli i Glass Feature	Cam Ölçüsü Glass Dimensions	Adet Quantity
4 + 12 + 4 mm 5 + 10 + 5 mm 6 + 8 + 6 mm	Kanat Ölçüsü - 50 mm 2845 mm x 684 mm	4 adet

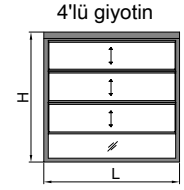

Profil Resmi Profile Picture	Açıklama Description	Kesim Ölçüsü Cutting Dimension	Adet Quantity	Kesim ekli Cutting Shape
	10550 Kutu Profili Tube Profile	L - 12	1 Adet	
	10551 Kutu Kapak Profili Tube Cover Profile	L - 12	1 Adet	
	10554 Kanat Profili Sash Profile	(H - 64) / 4	8 Adet	
		L - 105	8 Adet	
	10556 Kenet Profili Interlock Profile	(H / 4) - 13	2 Adet	
		L - 186	7 Adet	
	10559 Yatay Profili Transom Profile	L - 190	1 Adet	
	10559 Yatay Profili Transom Profile	L - 36	1 Adet	
	5992 Kapak Profili Cover Profile	L - 190	1 Adet	
	5992 Kapak Profili Cover Profile	L - 36	1 Adet	
	10552 Dikme Profili Mullion Profile	H - 145	2 Adet	
	10553 Dikme Profili Mullion Profile	H - 145	2 Adet	
	10553 Dikme Profili Mullion Profile	H - 160	4 Adet	
	8063 Kanal Kapak Profili Cover Profile	H - 1580	2 Adet	
		H - 882	2 Adet	

ALTERNATİF KANAT

	10555 Kanat Profili Sash Profile	(H - 64) / 4	8 Adet	
		L - 105	8 Adet	

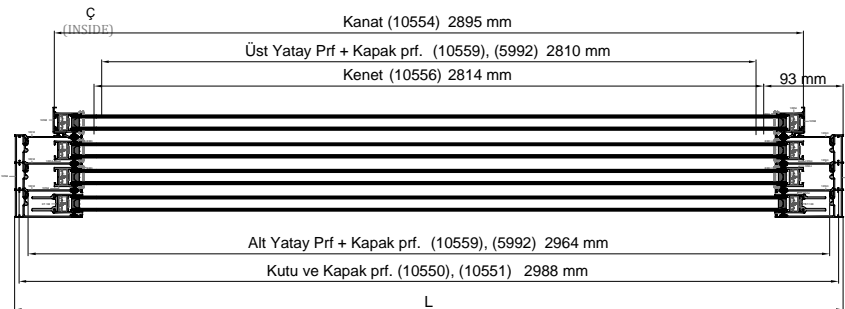
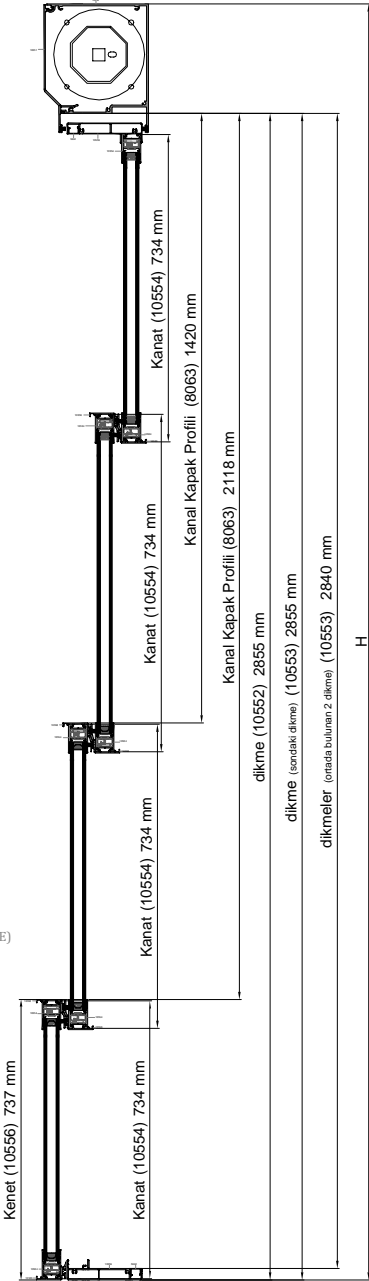

ÜST TRANSOMLU ALT EŞİKLİ DETAY (EŞİT OLMAYAN ÖLÇÜ)

Cam Özelli i Glass Feature	Cam Ölçüsü Glass Dimensions	Adet Quantity
4 + 12 + 4 mm	Kanat Ölçüsü - 50 mm 2845 mm x 595 mm	3 adet
5 + 10 + 5 mm	Kanat Ölçüsü - 50 mm 2845 mm x 950 mm	1 adet
6 + 8 + 6 mm		

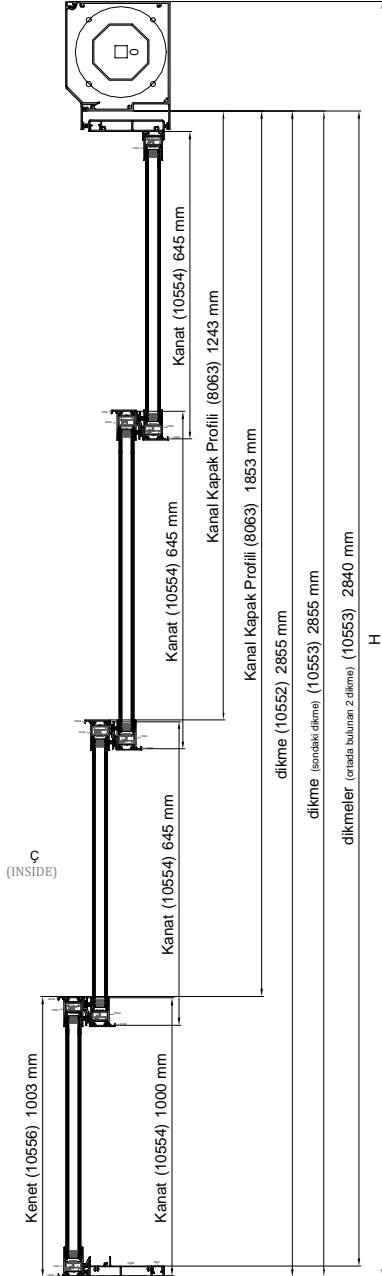
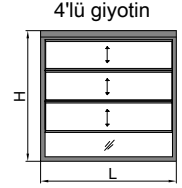

Profil Resmi Profile Picture	Açıklama Description	Kesim Ölçüsü Cutting Dimension	Adet Quantity	Kesim ekli Cutting Shape
	10550 Kutu Profili Tube Profile	L - 12	1 Adet	
	10551 Kutu Kapak Profili Tube Cover Profile	L - 12	1 Adet	
	10554 Kanat Profili Sash Profile	(H/4-105)	6 Adet	
		(H/3)	2 Adet	
		L-105	8 Adet	
	10556 Kenet Profili Interlock Profile	(H / 4) + 253	2 Adet	
		L-186	7 Adet	
	10559 Yatay Profili Transom Profile	L - 190	1 Adet	
	10559 Yatay Profili Transom Profile	L - 36	1 Adet	
	5992 Kapak Profili Cover Profile	L - 190	1 Adet	
	5992 Kapak Profili Cover Profile	L - 36	1 Adet	
	10552 Dikme Profili Mullion Profile	H - 145	2 Adet	
	10553 Dikme Profili Mullion Profile	H - 145	2 Adet	
	10553 Dikme Profili Mullion Profile	H - 160	4 Adet	
	8063 Kanat Kapak Profili Cover Profile	H - 1757	2 Adet	
		H - 1147	2 Adet	

ALTERNATİF KANAT

	10555 Kanat Profili Sash Profile	(H/4 - 100)	6 Adet	
		(H/3)	2 Adet	
		L - 105	8 Adet	

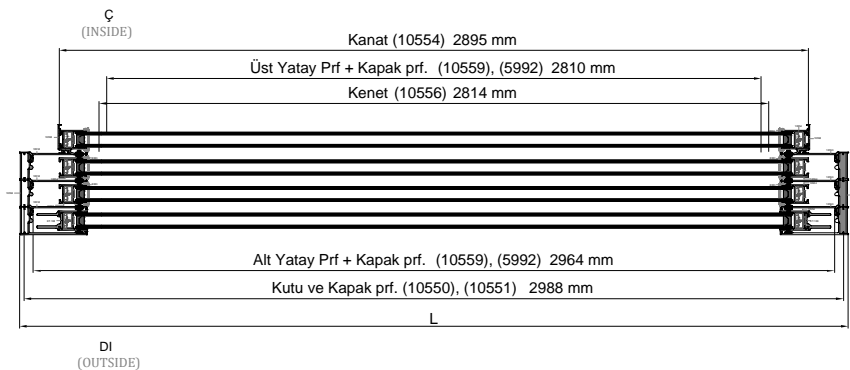



SH110 MOTORLU GİYOTİN SİSTEMİ

AKSESUAR LİSTESİ
(Accessory List)

3'lü giyotin

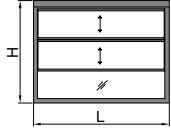

Aksesuar Resmi Accessory Picture	Açıklama Description	Kod Code	Adet Quantity
	YAN KAPAK COVER	14 100100	2 Adet
	Yatay Profil Kapağı (Yatay profili kullanıldığında hesaplanmalıdır.) HORIZONTAL TRANSAM COVER	14 100107	2 Adet
	70'lik Boru 1,2 mm 70 TUBE (1.2mm)	14 100120	(L) metre
	Boru Bağı TUBE PLUG	14 100105	1 Adet
	Rulman ROLLER	14 100106	1 Adet
	Rulman Plakası ROLLER COVER	14 100103	1 Adet
	Mosel Sel-70 120 Nm Radyo Alıcılı Giyotin Motoru MOSEL SEL-70 120Nm GULLÖTINE MOTOR WITH RECEIVER	09 080161	1 Adet
	Kasnak GEAR	14 100102	2 Adet
	Yük Kayışı LOAD SECURING STROP	14 100115	(Hx2) - 1 metre
	Kayı Bağlantısı STROP LINK	14 100101	2 Adet
	Köşe Bağlantısı CORNER CONNECTION	01 130306	12 Adet
	Kayı Tekerlek Adaptörü STROP WHEEL ADAPTER	14 100108	2 Adet
	Kanat Hiza Tekerleri SASH ALIGNMENT WHEEL	14 100111	8 Adet
	Askı Takımı HANGER SET	14 100104	2 Adet
	Ø3.9x16 Ysb Matkap Uçlu Vida Ø3.9x16 SELF DRILLING CURVED TOP SCREW	11 010201	20 Adet
	Ø4.8x60 Ysb Matkap Uçlu Vida Ø4.8x60 SELF DRILLING CURVED TOP SCREW	11 010225	32 Adet
	Poliüretan Yapıştırıcı POLYURETHANE ADHESIVE	08 050155	6 Tüp

Aksesuar Resmi Accessory Picture	Açıklama Description	Kod Code	Kesim Ölçüsü Cutting Dimension	Açıklama Description
	Fırça Fital (6.8 - 10 mm) WEATHER STRIP (6.8 - 10 mm)	03 050712	L x 6	metre
	Fırça Fital (6.8 - 5.5 mm) WEATHER STRIP (6.8 - 5.5 mm)	03 050707	H x 12	metre

Not: Kumanda opsiyoneldir

4'lü giyotin

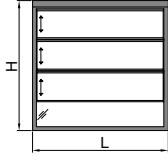

Aksesuar Resmi Accessory Picture	Açıklama Description	Kod Code	Adet Quantity
	YAN KAPAK COVER	14 100100	2 Adet
	Yatay Profil Kapa ı (Yatay profil kullanıldığı sırada hesaplanmalıdır.) HORIZONTAL TRANSAM COVER	14 100107	2 Adet
	70'lik Boru 1,2 mm 70 TUBE (1.2mm)	14 100120	(L) metre
	Boru Ba ı TUBE PLUG	14 100105	1 Adet
	Rulman ROLLER	14 100106	1 Adet
	Rulman Plakası ROLLER COVER	14 100103	1 Adet
	Mosel Sel-70 120 Nm Radyo Alicılı Giyotin Motoru MOSEL SEL-70 120mm GUILLOTINE MOTOR WITH RECEIVER	09 080161	1 Adet
	Kasnak GEAR	14 100102	2 Adet
	Yük Kayı ı LOAD SECURING STROP	14 100115	(Hx2) - 1 metre
	Kayı Ba lantısı STROP LINK	14 100101	2 Adet
	Kö e Ba lantı CORNER CONNECTION	01 130306	12 Adet
	Kayı Tekerlek Adaptörü STROP WHEEL ADAPTER	14 100108	2 Adet
	Kanat Hiza Tekerı SASH ALIGNMENT WHEEL	14 100111	12 Adet
	Askı Takımı HANGER SET	14 100104	2 Adet
	Ø3.9x16 Ysb Matkap Uçlu Vida Ø3.9x16 SELF DRILLING CURVED TOP SCREW	11 010201	20 Adet
	Ø4.8x60 Ysb Matkap Uçlu Vida Ø4.8x60 SELF DRILLING CURVED TOP SCREW	11 010225	32 Adet
	Poliüretan Yapı trıcı POLYURETHANE ADHESIVE	08 050155	6 Tüp

Aksesuar Resmi Accessory Picture	Açıklama Description	Kod Code	Kesim Ölçüsü Cutting Dimension	Açıklama Description
	Fırça Fıtil (6.8 - 10 mm) WEATHER STRIP (6.8 - 10 mm)	03 050712	L x 8	metre
	Fırça Fıtil (6.8 - 5.5 mm) WEATHER STRIP (6.8 - 5.5 mm)	03 050707	H x 14	metre

Not: Kumanda opsiyoneldir